

Screw Spacing

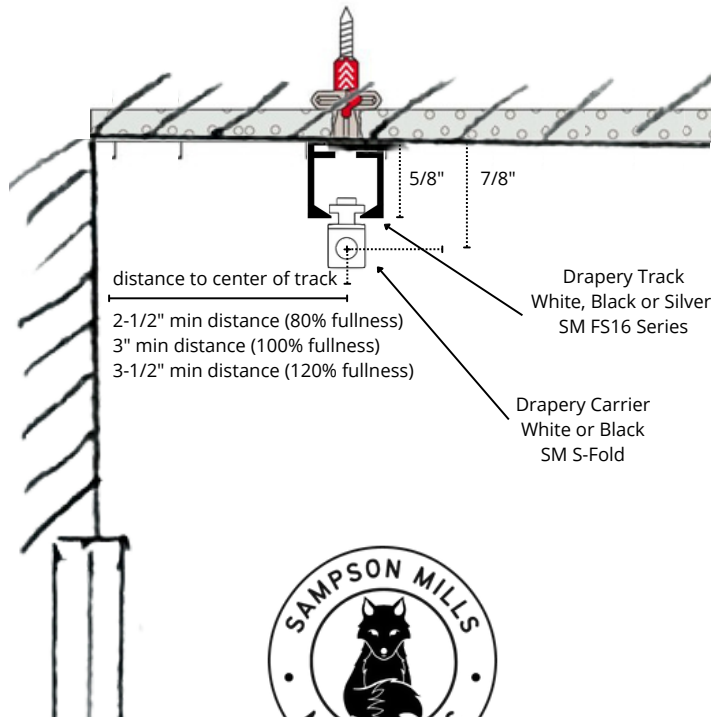

Install Video

www.SampsonMills.com

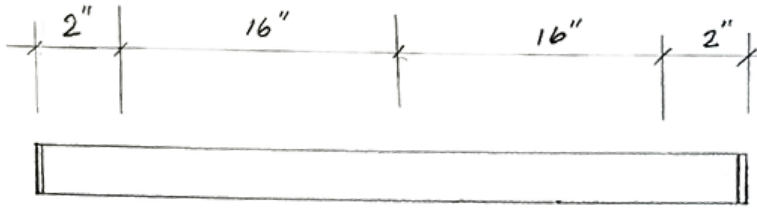

Website

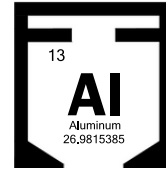

Installing FS 16 Tracks

! WARNING

Read instructions before installing.

**Must Use Profile Protector
Only use Sampson Mills Screws
or it will void the warranty.**

Read instructions before installing

Watch our Install Video for more details

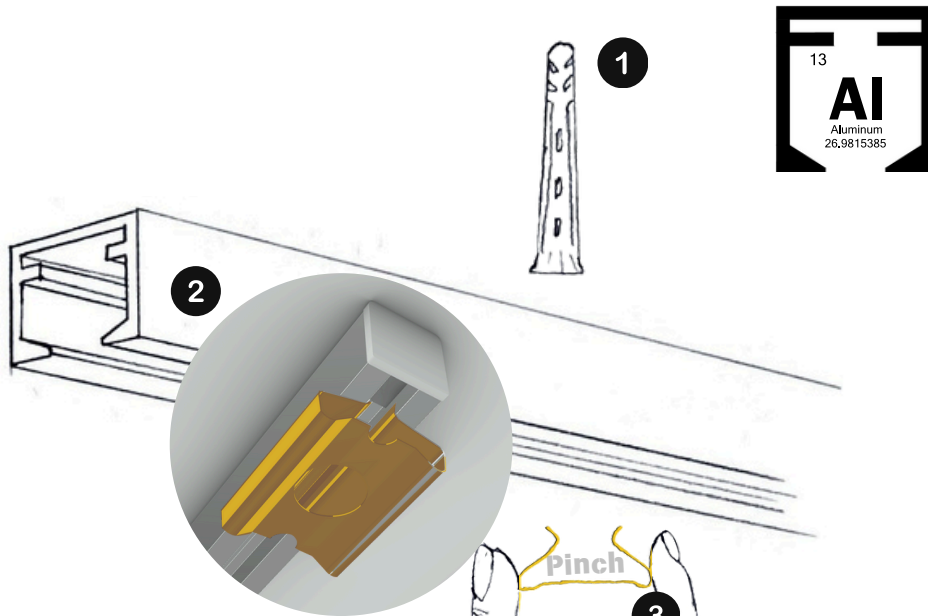

When Joining/Connecting Tracks

A

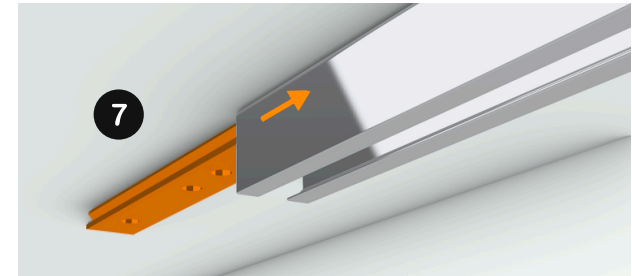

B

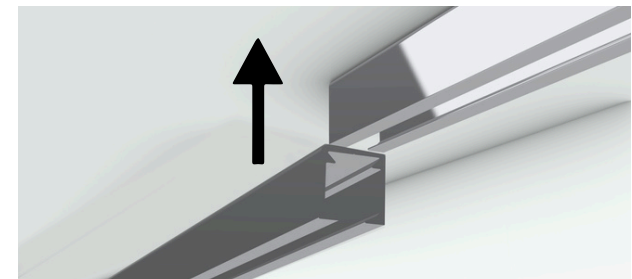

C

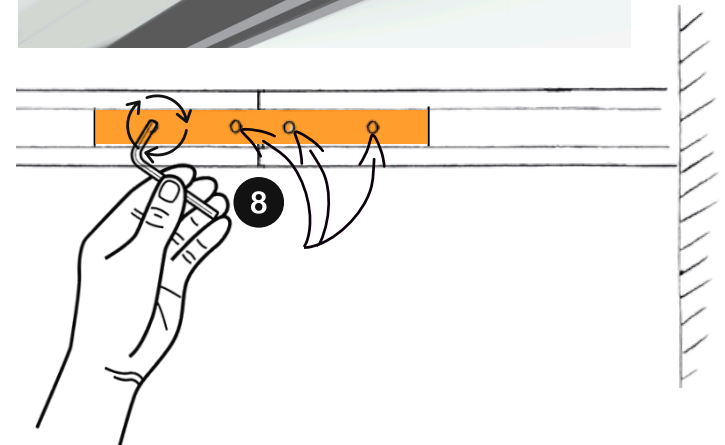

1 Fischer Anchor

2 FS16 Track

3 Profile Protector

4 Drill Bit

5 Trim Head #6 Screw

6 #1 Square Drive

7 Connecting Bridge

8 AK2 Allen Key

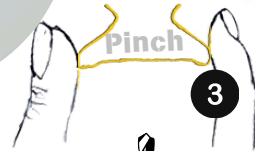

4



5



6